



# BB-15

## 1.75" Circle Billboard™

*All dimensions are actual size.*

-  **Bleed Line**  
*All background artwork should extend to this line (0.1" outside the Die Line)*
-  **Die Line**  
*Actual Billboard™ Shape*
-  **Imprint Area**  
*All important text/logos/info need to stay inside this line (0.1" inside of the Die Line)*

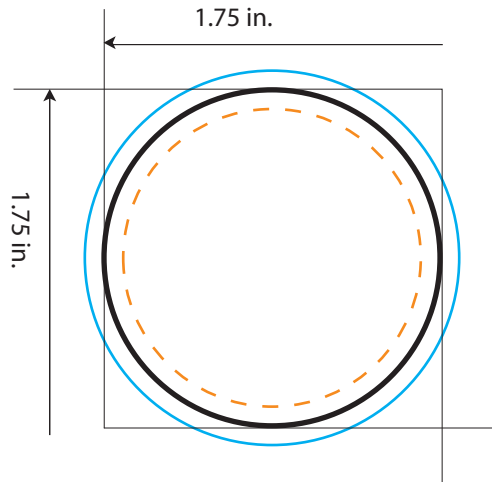

### COMMENTS:

All raster-based artwork should be at least 300 dpi. When sending vector artwork (Adobe Illustrator, Corel Draw, Macromedia Freehand) please convert all type to paths or outlines or include the printer and screen font files.